

## 20 Watt — LB20W V1.0

Third Generation: class 2 dimming, dim-to-1%-to-off, standby power <0.5W

CONSTANT CURRENT LED DRIVER WITH 0-10V DIMMING.

US & CN, LED Driver Class 2

LB Series Driver is a high-performance LED driver that provides smooth, continuous 1% dimming for virtually any LED fixture, whether it requires constant current. It provides the performance of class 2 isolating dimming and dim to off. It is the most versatile LED driver offered today due to its compatibility with a wide variety of LED arrays, multiple form factors, and numerous control options.



### Key Features

- Drive Mode: Constant Current, Dimming, Standby.
- Technology: Active PFC 1-Stage Switch Mode.
- Input Voltage: 120 to 277 Vac (UL), 100 to 240 Vac (ENEC).
- Output Power: 20 Watt Max.
- Dimming: Smooth & Continuous Dimming from 1% to 100%, dim-to-off. LEDs turn on to any dimmed level without going to full brightness. Constant Current Reduction (CCR) dimming methods.
  - 0-10V: 2 or 3-wire Analog / Digital Control Dimming (Isolated type).
- Output Voltage: 12 Vdc to 57 Vdc.
- Output Current: 350 mA to 830 mA (100% load).
- Efficiency: Up to 87%.
- Warranty: 5 years.

### Special Features

- Continuous dimming from 1% to 100%, dim to off.
- Safety isolation between primary and secondary.
- Dimming control is class 2 isolated from AC input and DC output.
- Standby power <0.5W (when dim to off).
- The dimming curve is optional (linear or logarithmic, default: linear).
- A rated lifetime of 50,000 hours @ Tc = 85°C.
- Safety: UL8750, 2<sup>nd</sup> Edition, UL1310 Class 2, CSA22.2, EN61347.
- EMC: FCC 47CFR Part 15, Class B @120V & Class A @277V, EN55015.
- Inrush current limiting circuitry: AC power line: line to line 2 kV, eliminates circuit breaker tripping, switch arcing and relay failure.
- Plastic shell, used with silicone potting. Meet the RoHs directive.
- IP66, NEMA4 compliant for dry, damp.
- 100% performance tested with CHROMA 8000 system at YG factory.
- 100% burned in with program-control test system at YG factory, at 50 degrees ambient temperature.

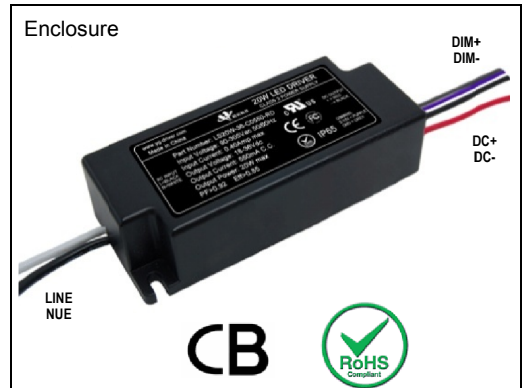

**Notice of use:**

1. The DIM+ line can't touch the DC+ line and AC line.
2. DC- cannot be shorted with the DIM-.

Size \ Unit	Inch	Millimeter
Case Length	3.74	95.00
Case Width	1.61	41.00
Case Height	0.98	25.00
Mounting Length	3.35	85.00

**LED wiring distance**

Recommended maximum wiring distance at full load.

AWG	#20	#19	#18	#17	#16
Distance (m)	14	18	22	28	36
Distance (ft)	45.9	59	72.2	91.9	118.1

### 20W 0-10V Dimming Part List

No.	Part Number	US Class 2	CN Class 2	Output Voltage Range	Output Current Range	Current Accuracy	Power Factor	Output Power	Max. Eff.	UL	cUL	ENEC	CB
1	LB20W-57-C0350-RD	Yes	Yes	28~57 Vdc	3.5 – 350 mA	±5%	0.90	20W	87%	✓	✓	✓	✓
2	LB20W-48-C0350-RD	Yes	Yes	24~48 Vdc	3.5 – 350 mA	±5%	0.90	16.8W	87%	✓	✓	✓	✓
3	LB20W-43-C0460-RD	Yes	Yes	21~43 Vdc	5.0 – 460 mA	±5%	0.90	20W	86%	✓	✓	✓	✓
4	LB20W-40-C0500-RD	Yes	Yes	20~40 Vdc	5.0 – 500 mA	±5%	0.90	20W	86%	✓	✓	✓	✓
5	LB20W-40-C0430-RD	Yes	Yes	20~40 Vdc	5.0 – 430 mA	±5%	0.90	17.2W	86%	✓	✓	✓	✓
6	LB20W-36-C0550-RD	Yes	Yes	18~36 Vdc	6.0 – 550 mA	±5%	0.90	20W	85%	✓	✓	✓	✓
7	LB20W-28-C0700-RD	Yes	Yes	14~28 Vdc	7.0 – 700 mA	±5%	0.90	20W	84%	✓	✓	✓	✓
8	LB20W-24-C0830-RD	Yes	Yes	12~24 Vdc	8.3 – 830 mA	±5%	0.90	20W	83%	✓	✓	✓	✓



### 20W Constant Current Part List

No.	Part Number	US Class 2	CN Class 2	Output Voltage Range	Output Current	Current Accuracy	Power Factor	Output Power	Max. Eff.	UL	cUL	ENEC	CB
1	LB20W-57-C0350	Yes	Yes	28~57 Vdc	350 mA	±5%	0.90	20W	87%	✓	✓	✓	✓
2	LB20W-48-C0350	Yes	Yes	24~48 Vdc	350 mA	±5%	0.90	16.8W	87%	✓	✓	✓	✓
3	LB20W-43-C0460	Yes	Yes	21~43 Vdc	460 mA	±5%	0.90	20W	86%	✓	✓	✓	✓
4	LB20W-40-C0500	Yes	Yes	20~40 Vdc	500 mA	±5%	0.90	20W	86%	✓	✓	✓	✓
5	LB20W-40-C0430	Yes	Yes	20~40 Vdc	430 mA	±5%	0.90	17.2W	86%	✓	✓	✓	✓
6	LB20W-36-C0550	Yes	Yes	18~36 Vdc	550 mA	±5%	0.90	20W	85%	✓	✓	✓	✓
7	LB20W-28-C0700	Yes	Yes	14~28 Vdc	700 mA	±5%	0.90	20W	84%	✓	✓	✓	✓
8	LB20W-24-C0830	Yes	Yes	12~24 Vdc	830 mA	±5%	0.90	20W	83%	✓	✓	✓	✓

### Input Specifications

Parameter	Min.	Typ.	Max.	Notes / Conditions
Input Voltage	100 Vac	---	277 Vac	100, 120, 230, 240, 277 Vac Nominal Values
Input Frequency	47 Hz	50/60 Hz	63 Hz	50/60 Hz Nominal
Input AC Current	---	---	0.20 A	Measured at 120 Vac / 60Hz Input, Output Full Load.
	---	---	0.10 A	Measured at 230 Vac / 50Hz Input, Output Full Load.
	---	---	0.09 A	Measured at 277 Vac / 60Hz Input, Output Full Load.
Inrush Current ( Peak )	---	20 A / 2uS	25 A / 3uS	Measured at 120 Vac / 60Hz Input, Output Full Load.
	---	30 A / 2uS	35 A / 3uS	Measured at 277 Vac / 60Hz Input, Output Full Load.
Leakage Current	---	---	300 μA	Measured at 120 Vac / 60Hz Input, Output Full Load.
	---	---	700 μA	Measured at 277 Vac / 60Hz Input, Output Full Load.
THD	---	12%	20%	Measured at 120, 230, 277 Vac Input, ≥ 70% Load.
Power Factor ( PF )	0.90	---	0.99	
Standby Power	0.1 W	0.2 W	0.5 W	Measured at 120, 230, 277 Vac Input, When dim to off ( $V_{dim} < 1.0V$ ).

### Output Specifications

Parameter	Min.	Typ.	Max.	Notes / Conditions
DC Output Voltage	Per Table	Per Table	Per Table	Per Tables on Page 1, The voltage is DC+ to DC-.
Output Constant Current	-5%	Per Table	+5%	Per Tables on Page 1
Flickering Index ( Vpk-pk )	---	---	25% Vo	20MHz BW, 1-100% dimming output in parallel with 0.1uF & 10uF CAP. Flickering Index is defined as $[(Y_{max}-Y_{min})/(Y_{max}+Y_{min})] * 100%$ . Y may be V or I
Flickering Index ( Ipk-pk )	---	25% Io	30% Io	
Line Regulation	-3%	---	+3%	Measured at 120-277 Vac Input, Output Full Load
Load Regulation	-4%	---	+4%	Measured at 120-277 Vac Input
Start-up Time	---	330ms	500ms	Measured at 120-277 Vac Input, Output Full Load
	---	460ms	500ms	Measured at 120-277 Vac Input, Dimming set at 50%
	---	1.0 s	1.3 s	Measured at 120-277 Vac Input, Dimming set at 10%
	---	1.8 s	2.1 s	Measured at 120-277 Vac Input, Dimming set at 1%
Output Overshoot	-5%	---	+10%	Measured at 120-277 Vac Input, When power on or off
Dim to Off Time	nc	---	0.4 s	Normal off. (default)
	-S	---	2.0 s	Soft off (Pending)

### Protection Specifications

Parameter	Min.	Typ.	Max.	Notes / Conditions
Output Short Circuit ( SCP )	---	---	---	No Damage. Auto recovery after short is removed.



Output Over Current ( OCP )	---	---	+10% Io	Constant Current Limiting circuit.
Output Over Voltage ( OVP )	---	---	+20% Vo	No Damage. Auto recovery after short is removed.
Temperature Protection (OTP)	95°C		110°C	At Tc from 95 to 110, the output current decreases linearly from maximum to zero.

### Dimming Specifications

Items	Parameter	Min.	Typ.	Max.	Notes / Conditions	
0-10V Dimming  (Compatible PWM, Rset Dimming, Additional datasheet)	Input Absolute Voltage	-2.0 V	10 V	15 V	Purple Wire	
	Output Source Current (Customizable)	---	---	0.56 mA	Purple Wire	
	Output Current Range in 0-10V Dimming (This note is in the case of linear dimming)	nc	0%	---	100%	Dim-to-off @ Vdim < 1.0V, 100% @ Vdim > 8.5V
		-A	1%	---	100%	1% @ Vdim < 1.2V, 100% @ Vdim > 8.5V
		-B	5%	---	100%	5% @ Vdim < 1.2V, 100% @ Vdim > 8.5V
		-C	10%	---	100%	10% @ Vdim < 1.2V, 100% @ Vdim > 8.5V
Output Current in 0-10V Pin Open	---	Normal	---	Maximum output		
Output Current in 0-10V Pin Short Circuit	---	Dim to Off	---	Into standby		
Output Current Delay	Transient Response of Dimming	---	600ms	---	Delay time, when Vdim steps from 0V to 10V	

### General Specifications

Parameter	Min.	Typ.	Max.	Notes / Conditions
Cooling	Convection			
MTBF	550,000 hours			Measured at 120 Vac input, 100% Load and Tc=85° C (MIL-HDBK-217F).
Life Time	50,000 hours			
Acoustic Noise	< 24 dB Class A			Not to exceed at 1 meter at any dim level.

### Environmental Specifications

Parameter	Min.	Typ.	Max.	Notes / Conditions
Case Temperature ( Tc )	-40 °C	---	+90 °C	Measured at location specified on case.
Operating Temperature ( Ta )	-40 °C	---	+60 °C	This is a reference range. Tc controls temperature range.
Storage Temperature ( Ts )	-40 °C		+85 °C	Non operating temperature range.
Operating Humidity	---	---	95% RH	Relative Humidity. Non-condensing.
Vibration	5 Hz	---	55 Hz	2G, 10 minutes / 1 cycle, period 30 minutes, each along X, Y, Z axis.

### Safety Compliance

Safety Category	Standards / Notes
UL / cUL	UL8750, UL1310 Class 2, UL1012 Non Class 2, CSA-C22.2 No. 107.1
CE	EN 61347-1:2007+A1:2010+A2:2012, EN61347-2-13:2014, EN 62493:15
Withstand Voltage	Input to Output: 2000 Vac (UL), 3750 Vac (CE, ENEC) Output to Dim: 2500 Vac
Isolation Resistance	Input to Output: >10MΩ, 500Vdc @ 25°C, 70% RH
0-10V Class 2 Isolated Dimming	DIM+ (Purple) / DIM- (Grey) are Class 2 Isolated from AC Input and DC Output.

### EMC Compliance

EMI Category	Standards
FCC	FCC 47CFR Part 15, ANSI C63.4: 2009
CE	EN55015:2013+A1:2015, EN 61000-3-2:2014, EN 61000-3-3:2013

Energy Star	Energy Star transient protection: Ballast or driver shall comply with ANSI/IEEE C62.41.1-2002 and ANSI/IEEE C62.41.2-2002, Category A operation. The line transient shall consist of seven strikes of a 100KHZ ring wave, 2.5KV level, for both common mode and differential mode.
EMS Category	Notes
EN 61000-4-2	Electrostatic Discharge (ESD): 8 kV air discharge, 4 kV contact discharge
EN 61000-4-3	Radio-Frequency Electromagnetic Field Susceptibility Test-RS
EN 61000-4-4	Electrical Fast Transient / Burst-EFT
EN 61000-4-5	Surge Immunity Test: AC Power Line: line to line 2 kV
EN 61000-4-6	Conducted Radio Frequency Disturbances Test-CS
EN 61000-4-11	Voltage Dips
EN 61547	Electromagnetic Immunity Requirements Applies To Lighting Equipment

Note: the above test data are in the condition of 25 C ambient temperature, except for the marked temperature.

## Typical Applications

### ■. Constant Current Driver

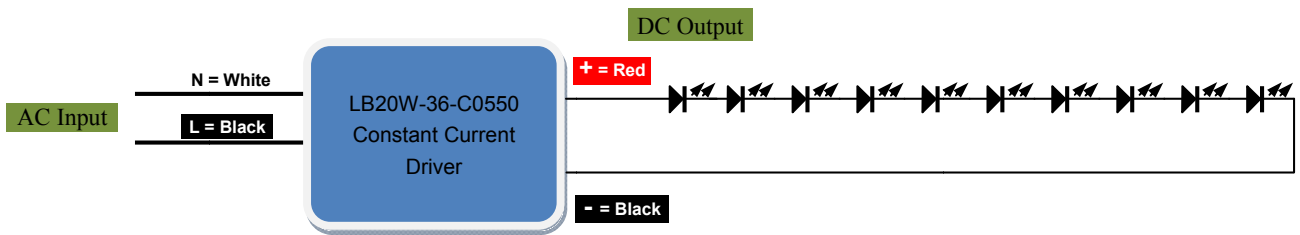

### ■. 0-10V Dimming Driver

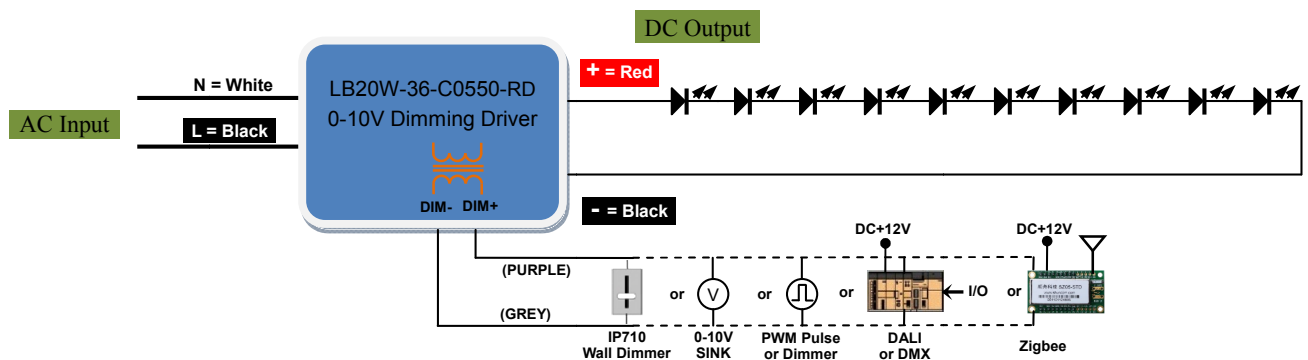

### Dimming Curve

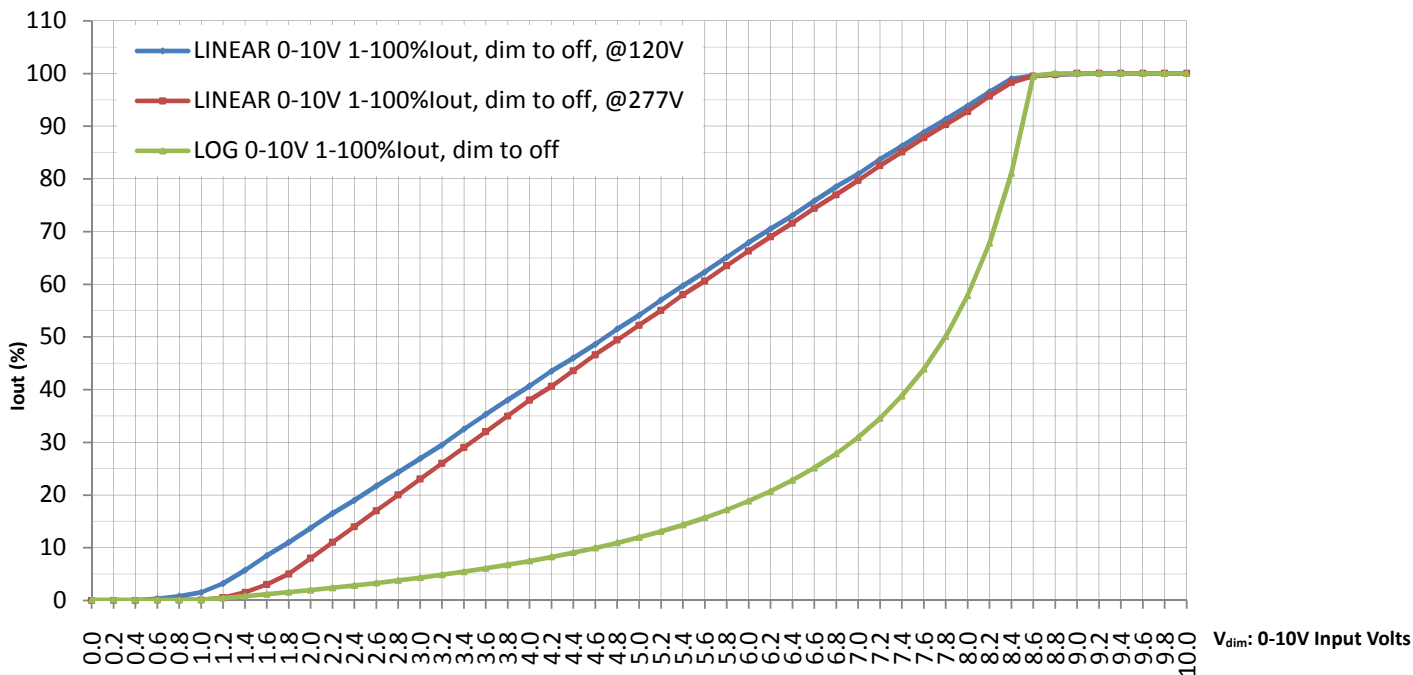

Note:

1. The dimming curve is optional (linear or logarithmic, default: linear).
2. The logarithmic curve needs to be specified.

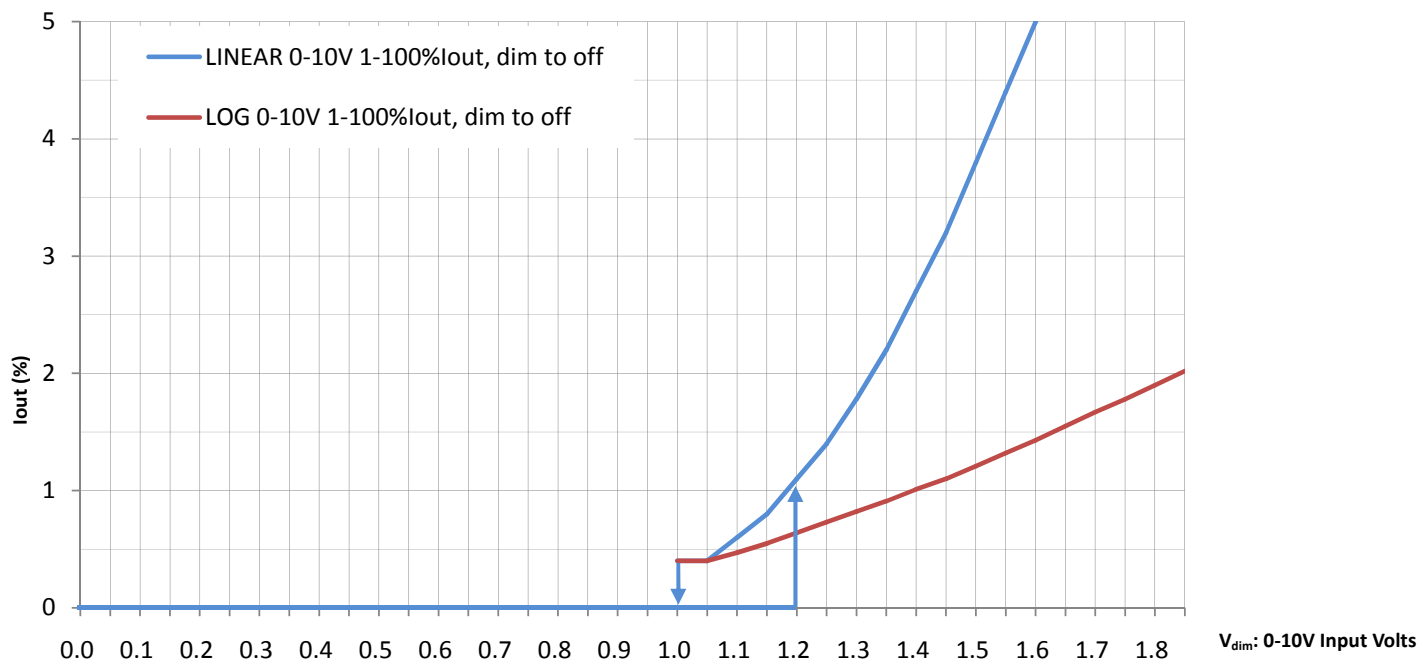

Note: V<sub>dim\_ON</sub> is 1.2V, V<sub>dim\_OFF</sub> is 1.0V. Driver goes into standby state, when V<sub>dim</sub> is less than 1.0V.

**Iout Transient Response vs Vdim Step**

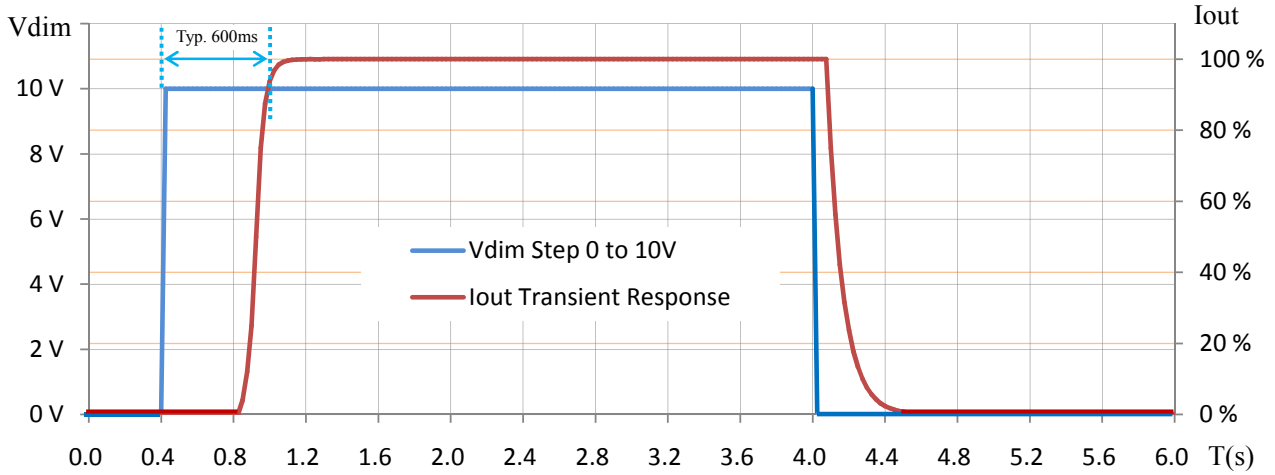

**Output current decreases linearly vs. Tc temperature**

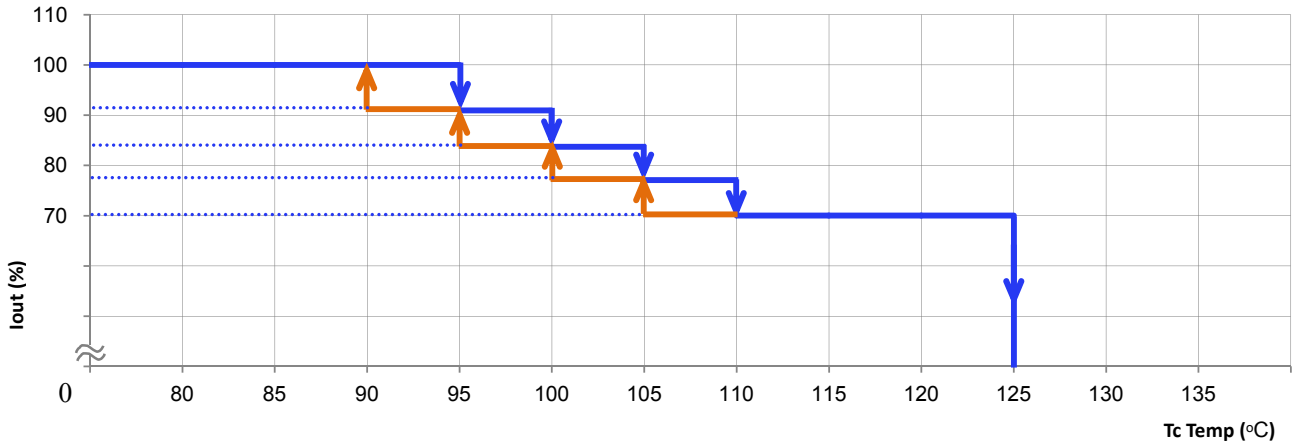

**Power Operating Window**

The DLC working area of output 36V/550mA.

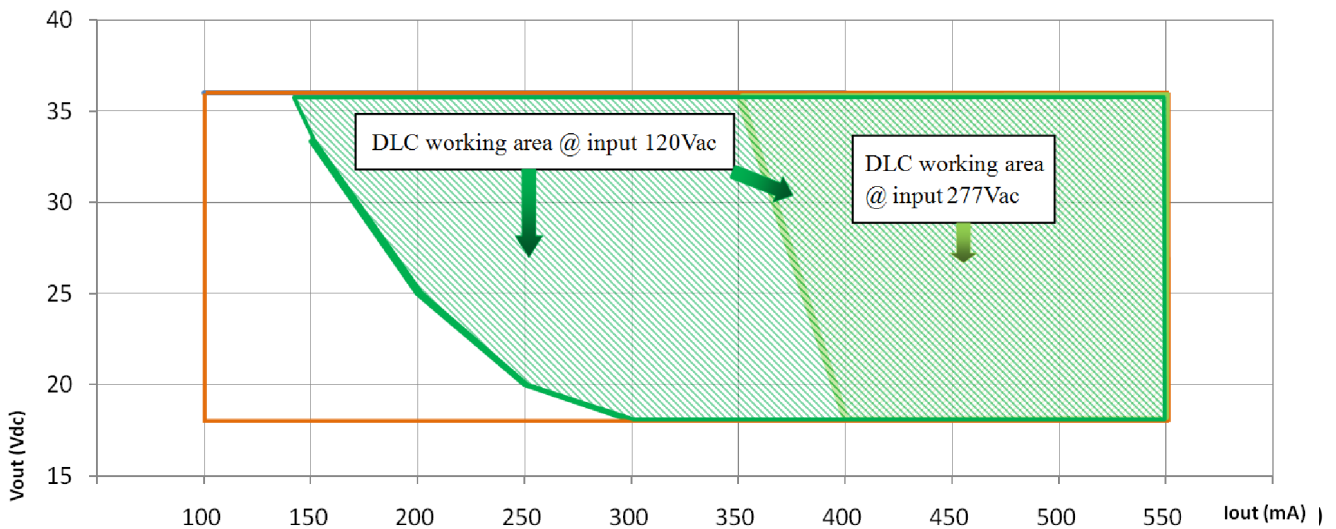

**Characteristic Curve**

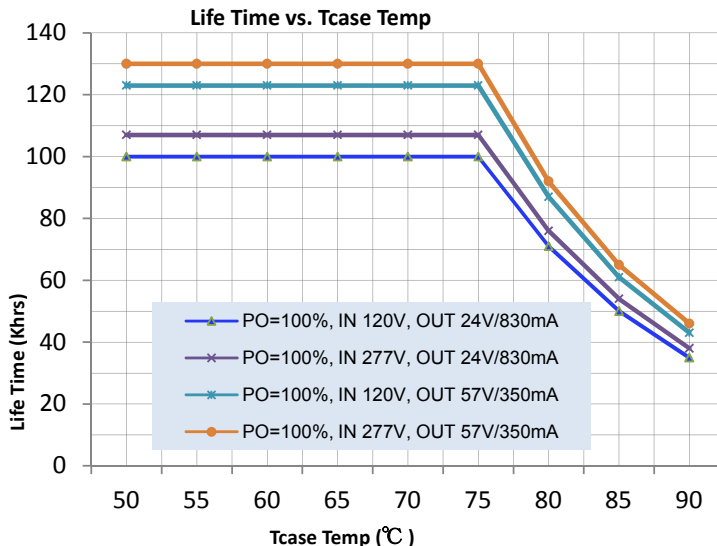
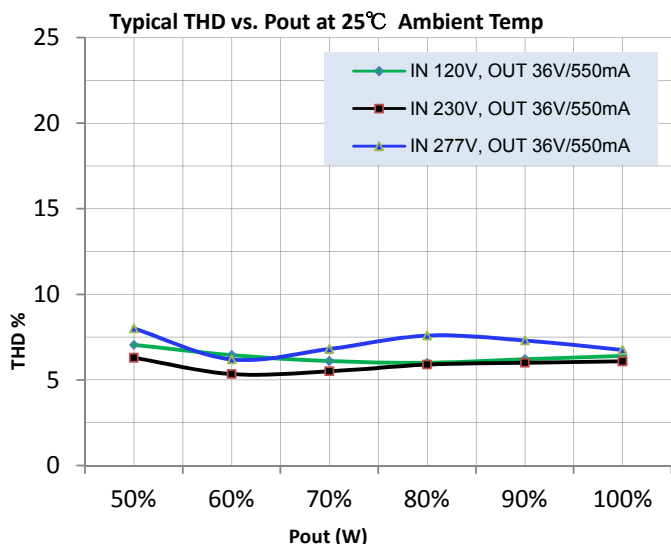
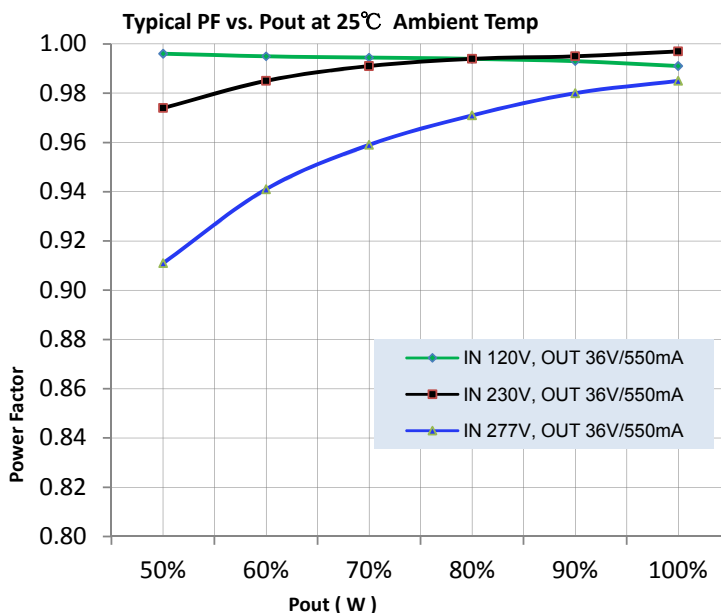
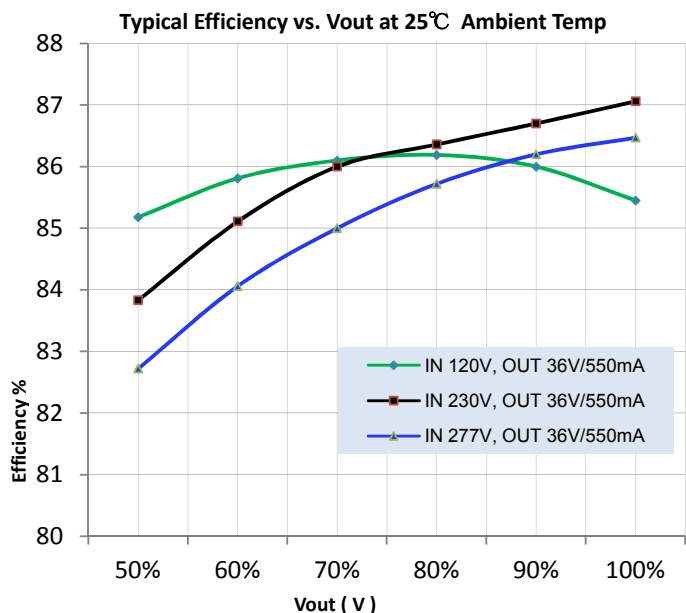

**Installation**

AC input for connection the two core ANSI/UL1015/AWG18 temperature 105 °C core copper wire connection.

Cable Length: 150mm, stripping on the tin: 10mm.

Where: L — Black wire, N — White wire.

DC output for connection the two core ANSI/UL1569/AWG18 temperature 105 °C core copper wire.

Cable Length: 150mm, stripping on the tin: 10mm.

Where: DC+ — Red, DC- — Black.

The dimmer control input is the two copper wires, ANSI/UL1569/AWG22 & temperature 105 °C.

Cable Length: 150mm, stripping on the tin: 10mm.

Where: DIM+ (0-10V) input — Purple wire, DIM- — Grey wire.

This product has two Φ4.0mm mounting holes.

**Order ID**

P/N: LB20W - 36 - C0550 - RDL - A

-NC	-A
-RD	-B
-RDL	-C

**Note:**

- RD Linear dimming curve
- RDL Logarithmic dimming curve

P/N 1: LB20W-36-C0550

Description: 20W, 36Vdc voltage max, constant current 550mA, constant current mode.

P/N 2: LB20W-36-C0550-RD

Description: 20W, 36Vdc voltage max, current 550mA max, minimum dimming to 1%, dim-to-off, normal off, 0-10V dimming mode.

P/N 3: LB20W-36-C0550-RD-A

Description: 20W, 36Vdc voltage max, current 550mA max, minimum dimming to 1%, 0-10V dimming mode.

P/N 4: LB20W-36-C0550-RD-B

Description: 20W, 36Vdc voltage max, current 550mA max, minimum dimming to 5%, 0-10V dimming mode.

P/N 5: LB20W-36-C0550-RD-C

Description: 20W, 36Vdc voltage max, current 550mA max, minimum dimming to 10%, 0-10V dimming mode.

**Product size**

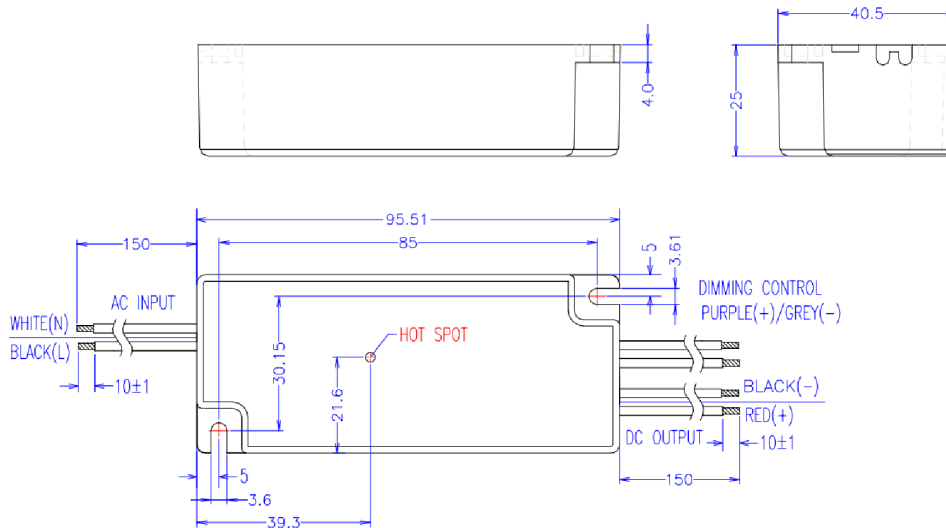

Notes: The Driver Tc (HOT SPOT) should be located at side of case.



**Application note**

Picture 1

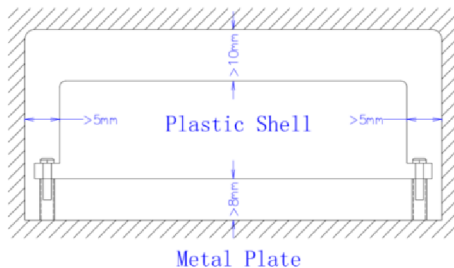

Picture 2

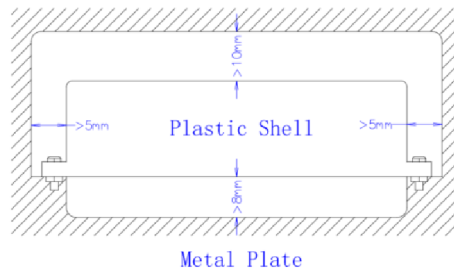

In Picture 1 and Picture 2, EMC has the best.

**Note :**

- The independent LED drive conforms to the EMC standard.  
But it is not guaranteed to be qualified, when the drive is mounted in the LED lamp.
- Please forgive us for any discrepancy due to the update of the specifications or the upgrade of the product.  
If you need the latest information, please contact our marketing department.